

NOTES:

1. MATERIAL OF CONSTRUCTION: TYPE 316L, STAINLESS STEEL
2. MTR/HEAT NUMBERS ARE PROVIDED AND SHALL MEET APPLICABLE MATERIAL SPECIFICATIONS.
3. FLANGE BOLT HOLES TO STRADDLE COMMON CENTERLINES, UNLESS OTHERWISE NOTED.
4. INLET/OUTLET CONNECTION: 1.00" NOMINAL DIA., ANSI B16.5, CLASS 150, SCHED. 40, RAISED FACE - WELD NECK FLANGE
5. WELDING JOINTS TO BE COMPLETE JOINT PENETRATION, WHERE POSSIBLE.
6. HYDROTESTING MAY BE PERFORMED IN ACCORDANCE WITH MAZZEI SOP NO. 6090.
7. DYE PENATRATE TESTING MAY BE PERFORMED IN ACCORDANCE WITH MAZZEI SOP NO. 6095.
8. CLEANED FOR PASSIVATION PER ASTM A380 GUIDELINES.
9. PASSIVATED PER ASTM A967 SPECIFICATION.
10. FINISH: EXTERIOR BEAD BLASTED.
11. WELD MAP, NON DESTRUCTIVE TESTING (NDT), CLEANING AND INSPECTION REPORTS TO BE PROVIDED BY MAZZEI.

REVISIONS			
REV.	DESCRIPTION	DATE	APPROVED
NC	RELEASED FOR SUBMITTAL.	5/28/2014	J. BENNETT

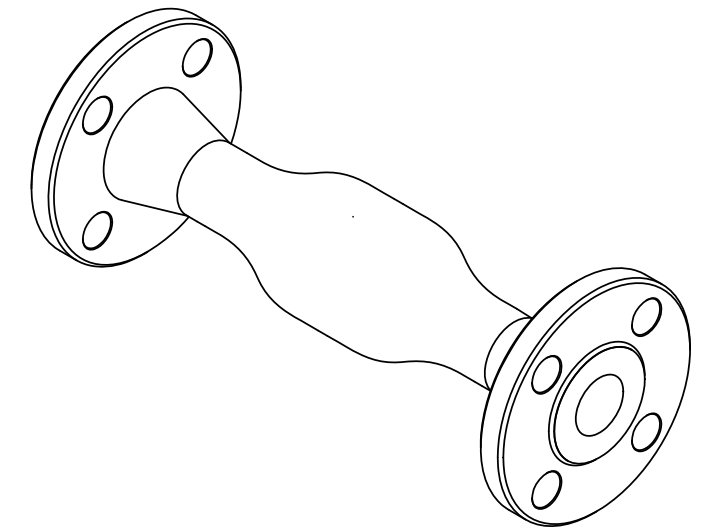

(ISOMETRIC VIEW)  
(FOR REFERENCE ONLY)

**SUBMITTAL DRAWING**

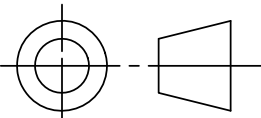
<b>SUBMITTAL NOTICE</b>	<b>CONFIDENTIALITY NOTICE</b>	UNLESS OTHERWISE SPECIFIED DIM ARE IN INCHES TOL ON ANGLE $\pm .1/2^\circ$ 1 PL $\pm .125$ 2 PL $\pm .060$ 3 PL $\pm .030$ INTERPRET DIM AND TOL PER ASME Y14.5M-1994	<b>APPROVALS</b>	<b>DATE</b>		<b>MAZZEI INJECTOR CO., LLC</b> 500 ROOSTER DRIVE BAKERSFIELD, CA 93307 PHONE: (661) 363-6500 FAX: (661)363-7500 WWW.MAZZEI.NET
ANY RECOMMENDATIONS FOR PRODUCT AND/OR SYSTEM DESIGN, WHETHER CONTAINED IN A DOCUMENT, WITHIN THIS DRAWING, COMMUNICATED BY ELECTRONIC MEANS OR GIVEN VERBALLY, ARE INTENDED SOLELY AS GUIDELINES TO ACTUAL SYSTEM DESIGN. SAID RECOMMENDATIONS ARE BASED UPON INFORMATION SUPPLIED BY OTHERS, THE ACCURACY OF WHICH IS BEYOND VERIFICATION BY MAZZEI INJECTOR CO. LLC. THEREFOR MAZZEI CANNOT AND DOES NOT WARRANT THE SUITABILITY OF ITS PRODUCTS FOR A PARTICULAR SERVICE NOR THE PERFORMANCE OF ANY SYSTEM CONTAINING COMPONENTS MADE OR SOLD BY MAZZEI.	THE INFORMATION CONTAINED IN THIS DRAWING IS THE SOLE PROPERTY OF MAZZEI INJECTOR COMPANY LLC. ANY REPRODUCTION IN PART OR AS A WHOLE WITHOUT THE WRITTEN PERMISSION OF MAZZEI IS STRICTLY PROHIBITED.	<b>THIRD ANGLE PROJECTION</b> 	DRAWN: T. JOHNS	5/28/2014	<b>FLASH REACTOR; FRF01012AA00</b>	
			CHECKED: K. COBAR	5/28/2014		
			APPROVED: J. BENNETT	5/28/2014		
	DRAWING MAY NOT BE PRINTED FULL SIZE DO NOT SCALE		QA: -			
			CUSTOMER APPROVAL: -			
			CUSTOMER: NA		SIZE: <b>B</b> JOB NO.: <b>NA</b> DRAWING NUMBER: <b>FRF01012AA00-SUB</b> REV: <b>NC</b>	
					SCALE: <b>NONE</b> WEIGHT: <b>6 LBS</b> SHEET: <b>1 OF 2</b>	

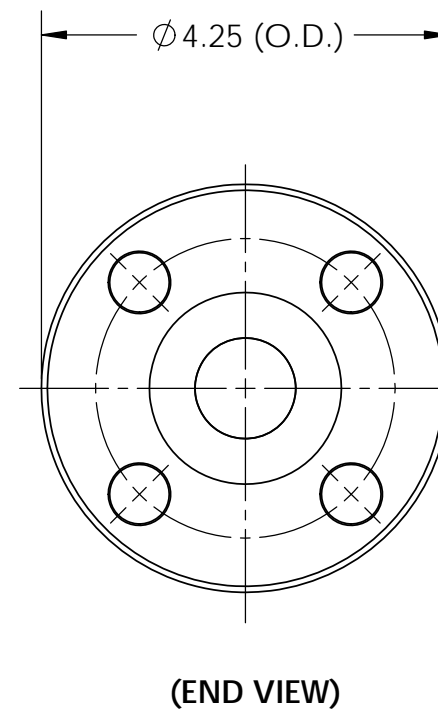
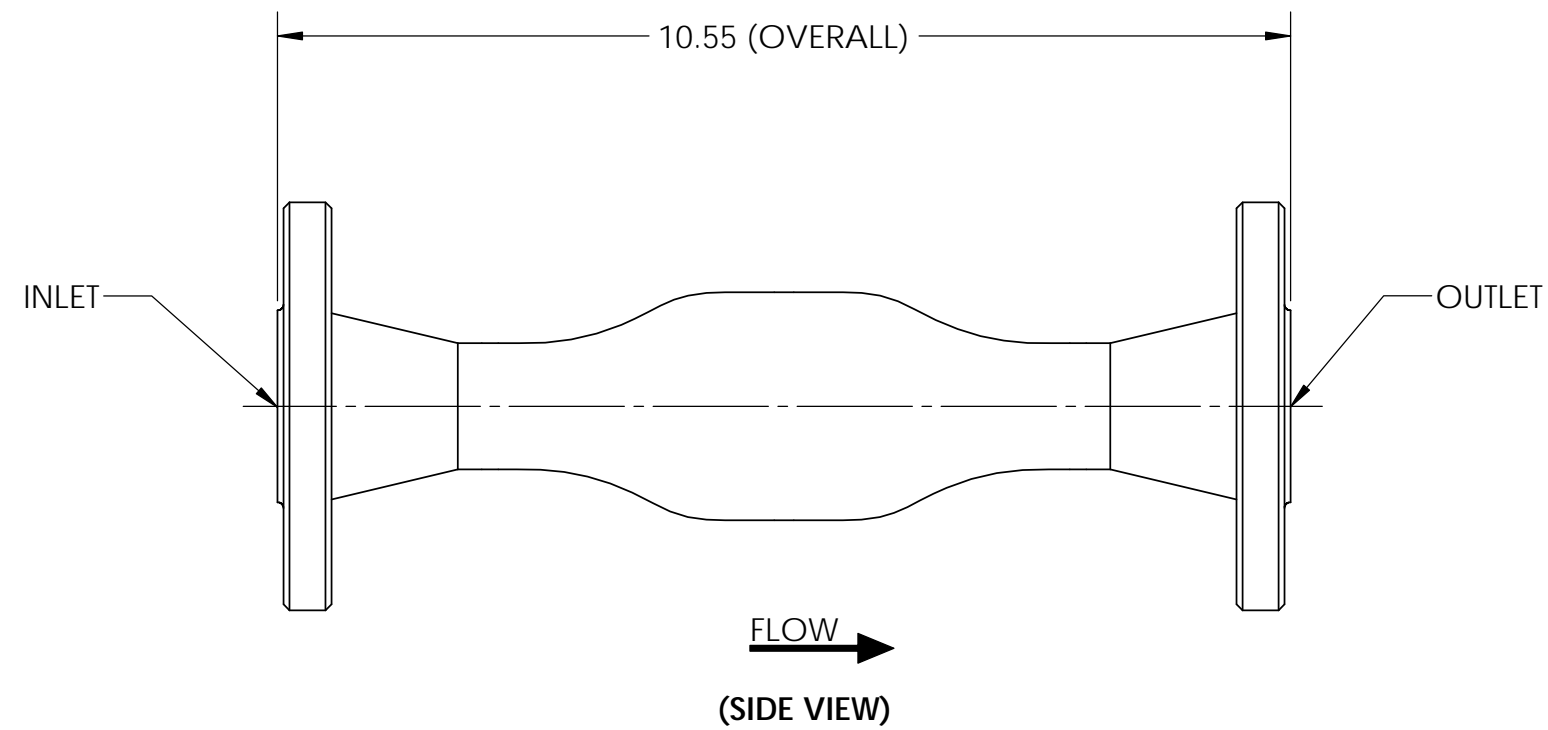

		<b>MAZZEI INJECTOR CO., LLC</b> 500 ROOSTER DRIVE BAKERSFIELD, CA 93307 PHONE: (661) 363-6500 FAX: (661)363-7500 WWW.MAZZEI.NET	
		TITLE: <b>FLASH REACTOR; FRF01012AA00</b>	
SIZE:	JOB NO.:	DRAWING NUMBER:	REV.:
<b>B</b>	<b>NA</b>	<b>FRF01012AA00-SUB</b>	<b>NC</b>
SCALE:	WEIGHT:	SHEET:	
<b>1:2</b>	<b>6 LBS</b>	<b>2 OF 2</b>	



MAZZEI® FLASH REACTOR™ FRF01012A

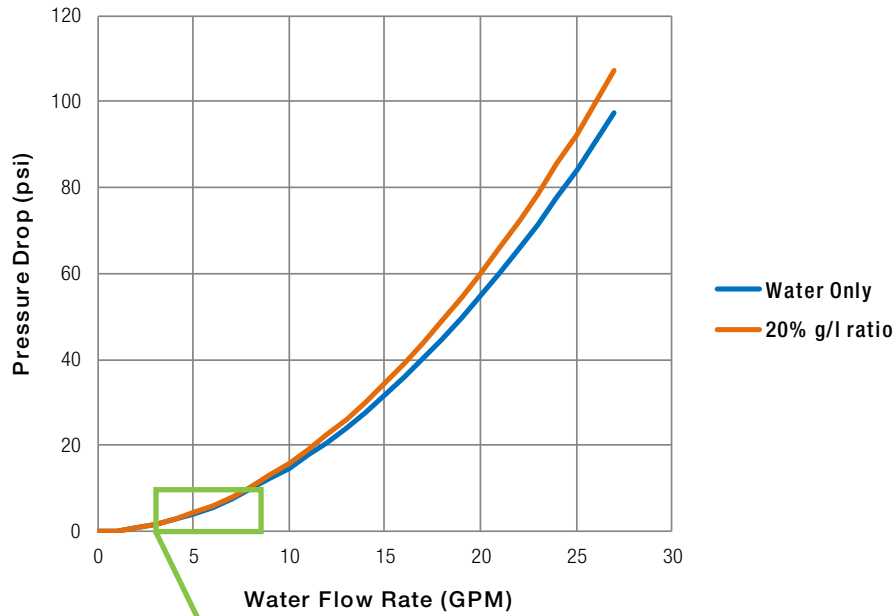

MAZZEI® FLASH REACTOR™ FRF01012A

